

DUPONT LIBRARY

MEGHAN REYNOLDS, DEC. 09, 2019

ARCH 401, CRAWFORD



EXTERIOR PERSPECTIVE



LOCATION MAP
NTS



SITE PLAN
1" = 1/32"



WEST ELEVATION

1' = 1/8"

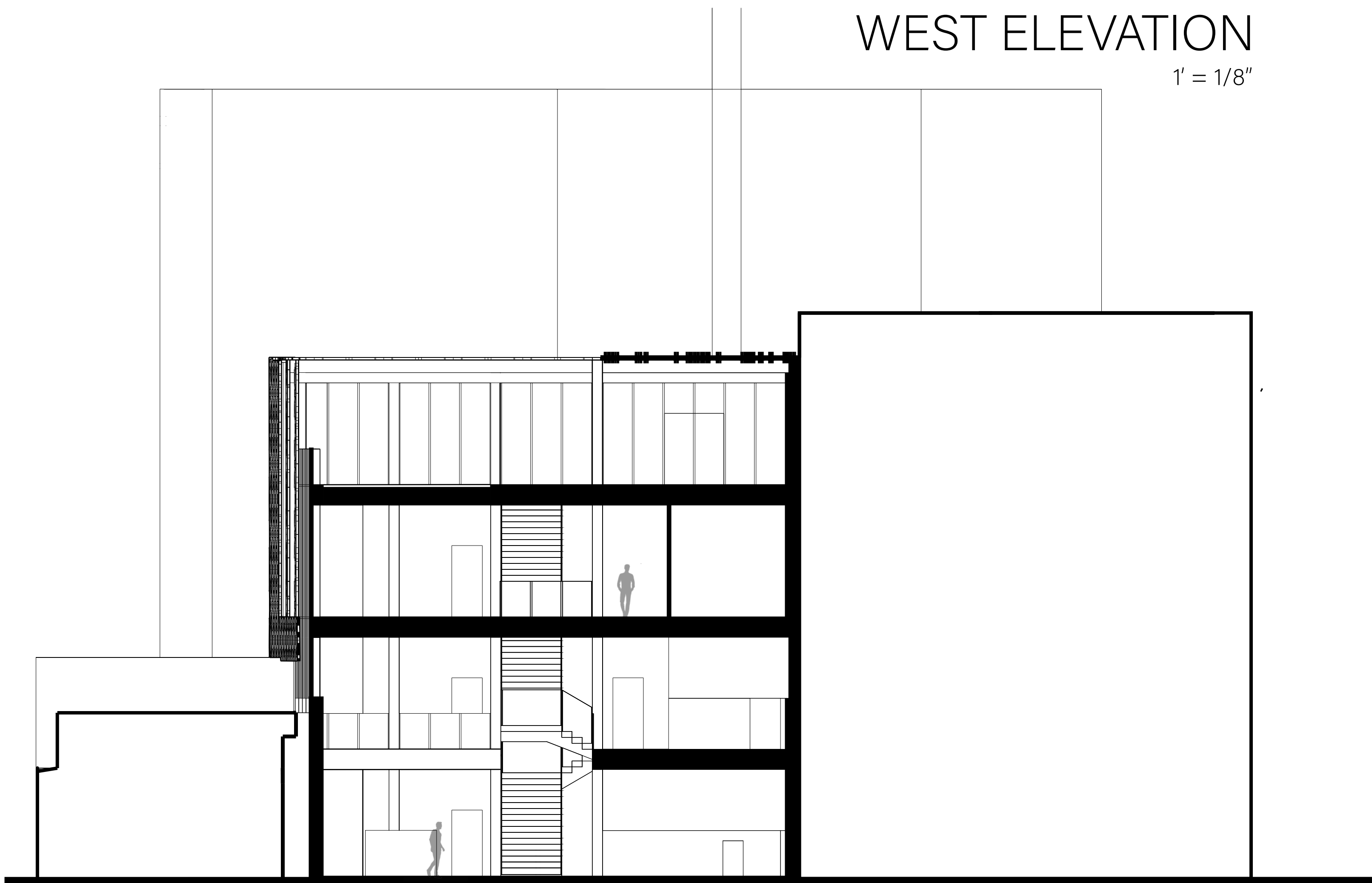

SECTION 1

1' = 1/8"



ROOFTOP PERSPECTIVE



THIRD FLOOR PERSPECTIVE



- 1 LOBBY/ BOOK CHECKOUT
- 2 CHILDRENS AREA
- 3 MAIN LIBRARY
- 4 CLASSROOMS
- 5 PRIVATE READING ROOMS
- 6 RESTROOMS
- 7 SPECIAL COLLECTIONS
- 8 SERVICE
- 9 EMPLOYEE AREA
- 10 ROOFTOP SITTING/GREENROOF

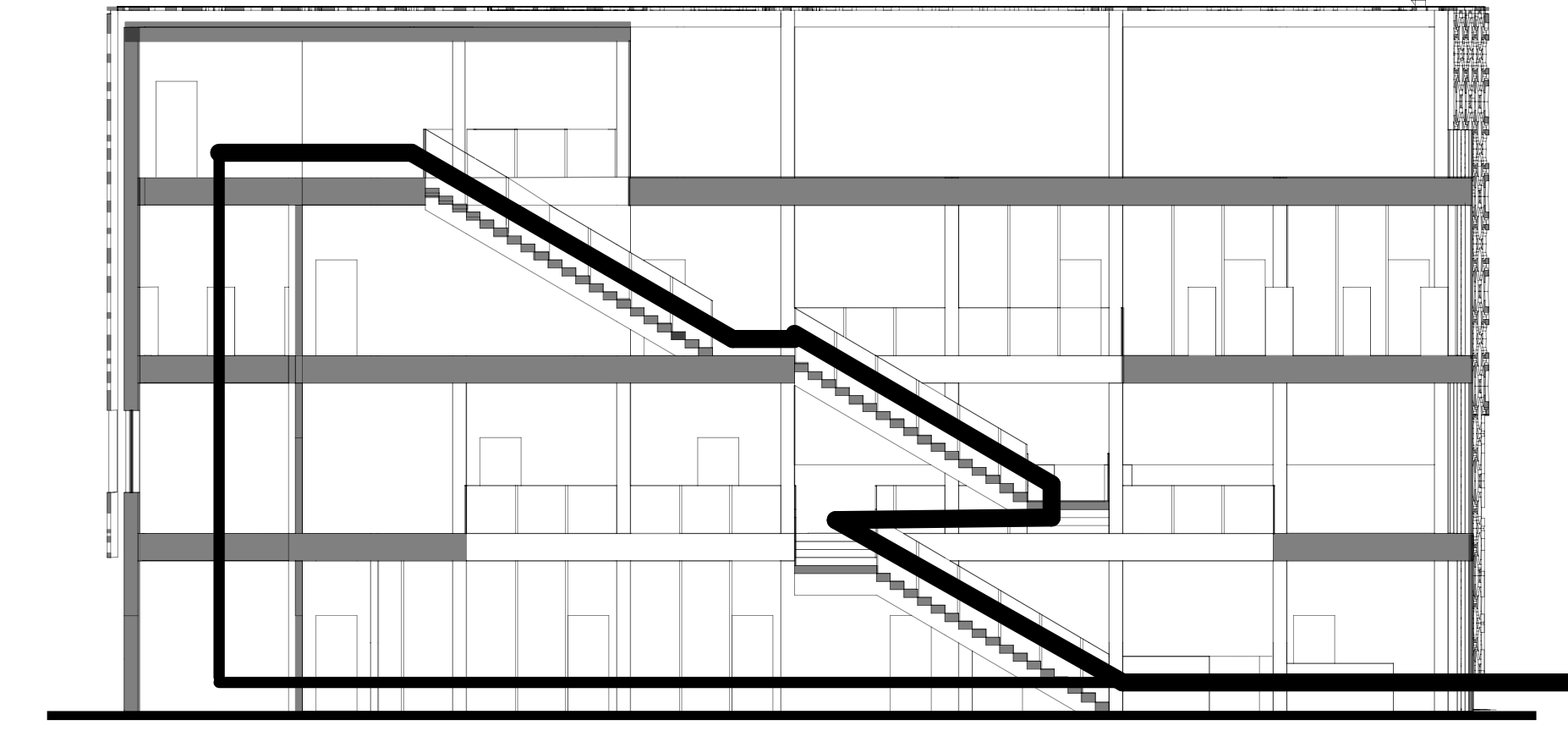
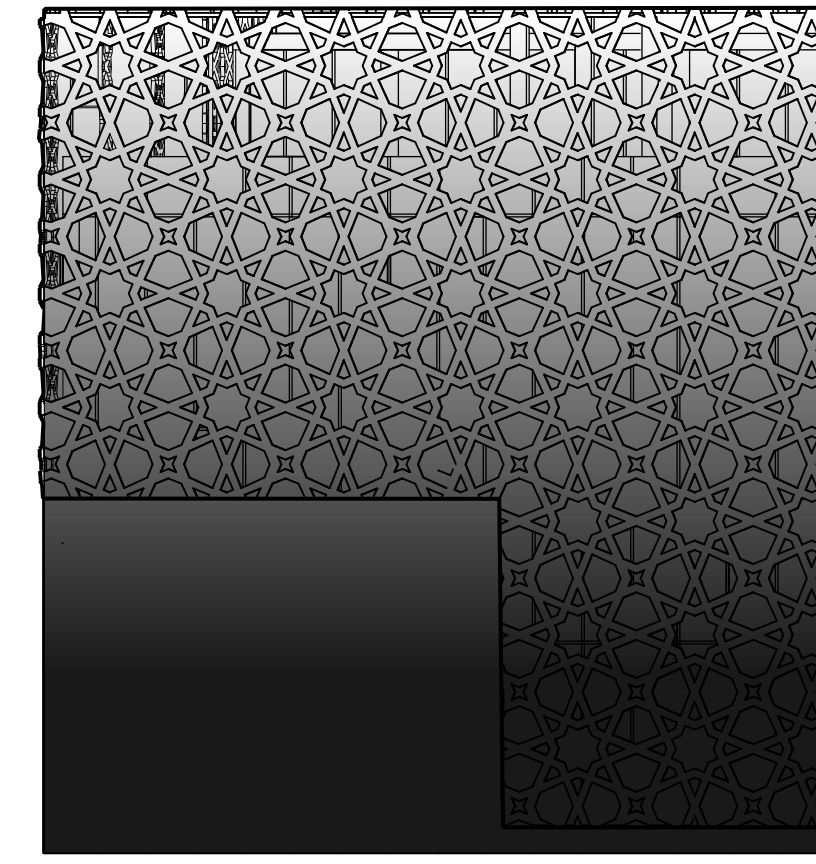

PROGRAM

PATTERN

CIRCULATION

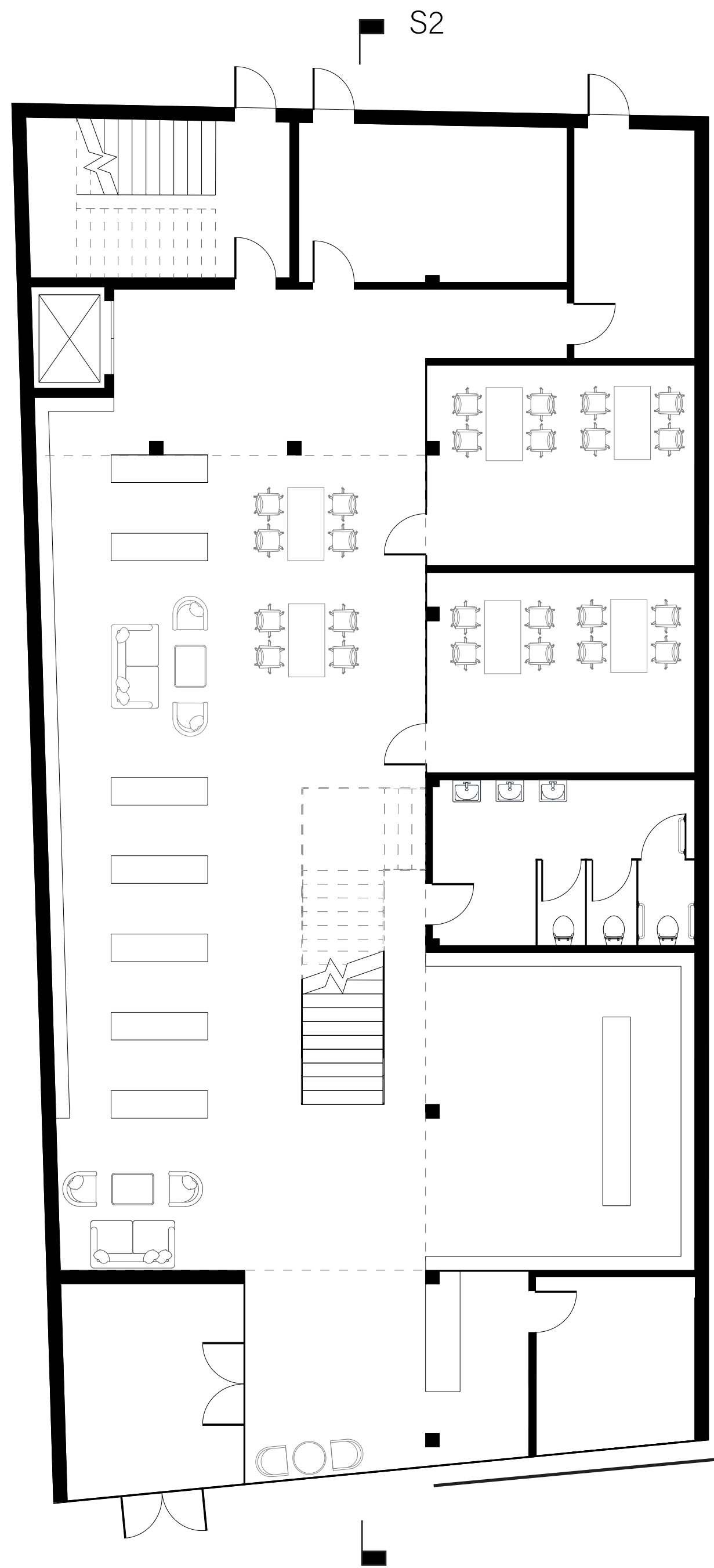

⊖ FIRST FLOOR
1' = 1/8"

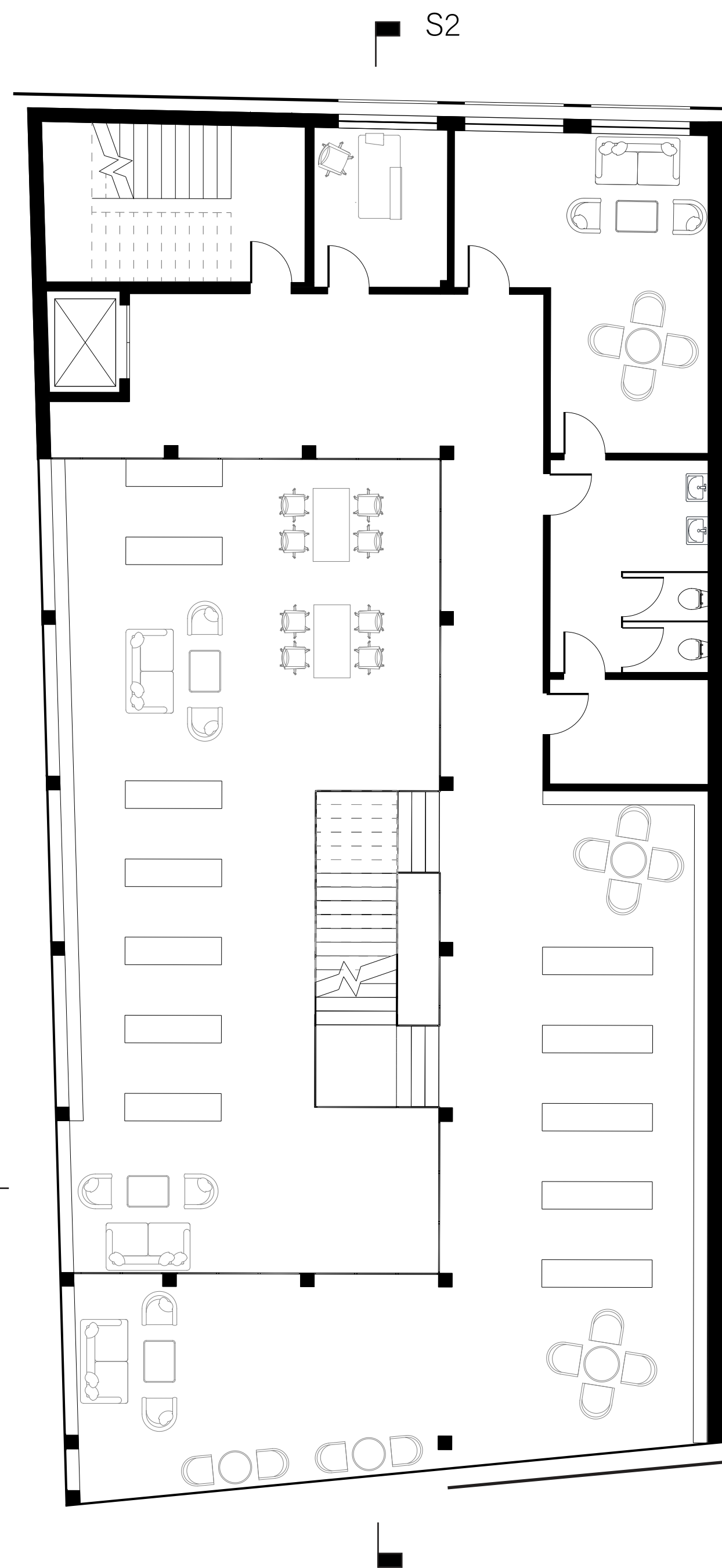

⊖ SECOND FLOOR
1' = 1/8"

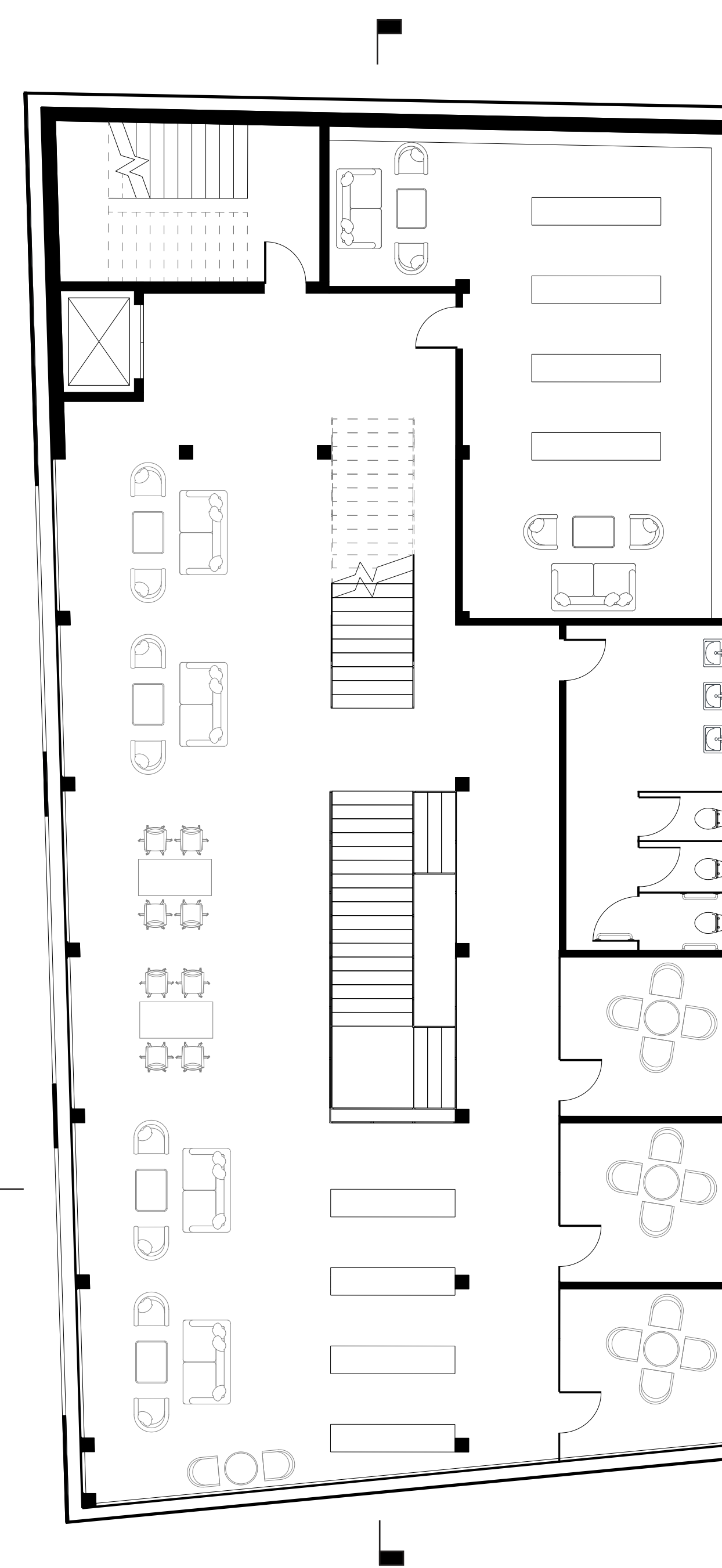

⊖ THIRD FLOOR
1' = 1/8"

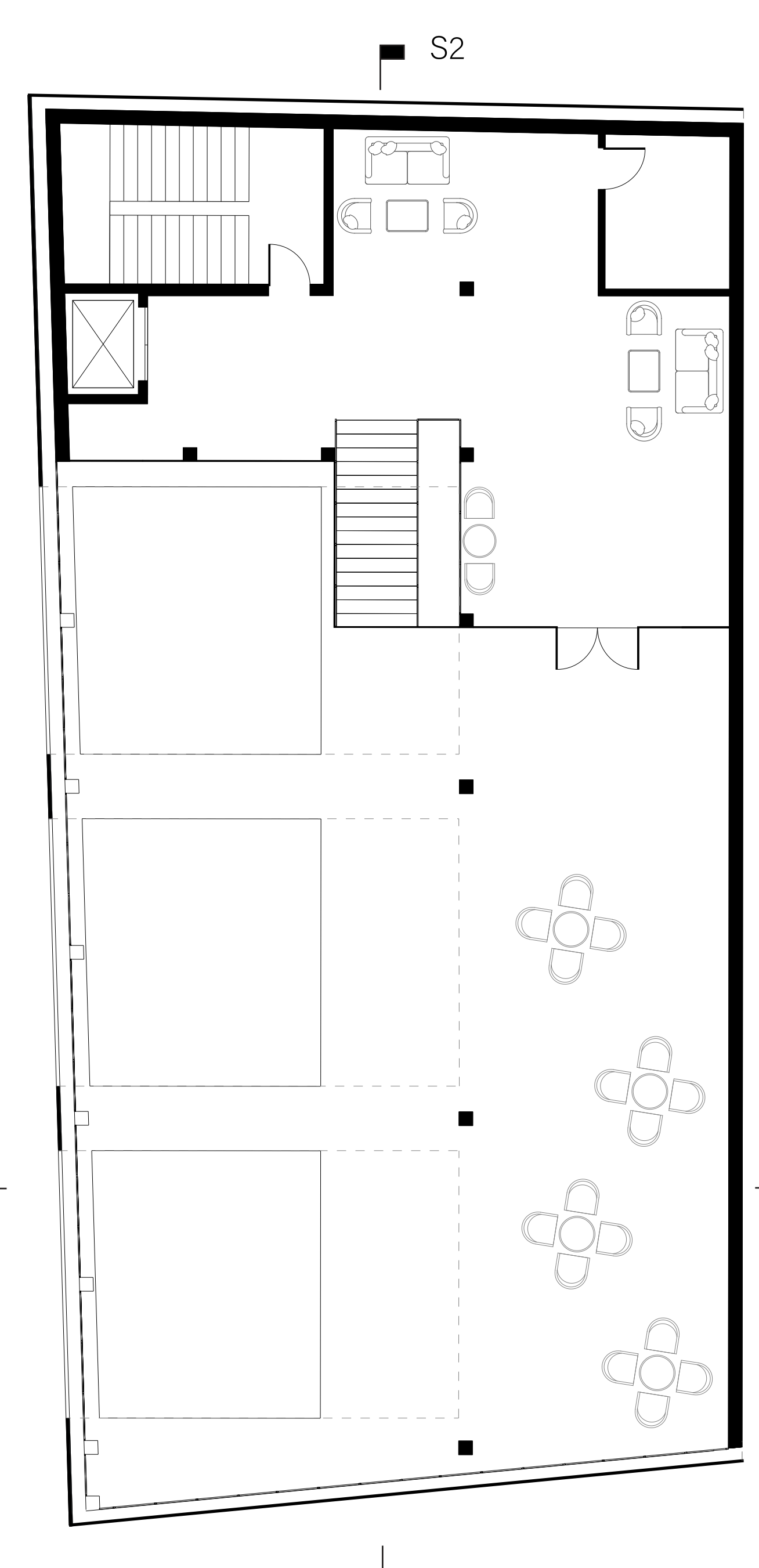

⊖ FOURTH FLOOR
1' = 1/8"

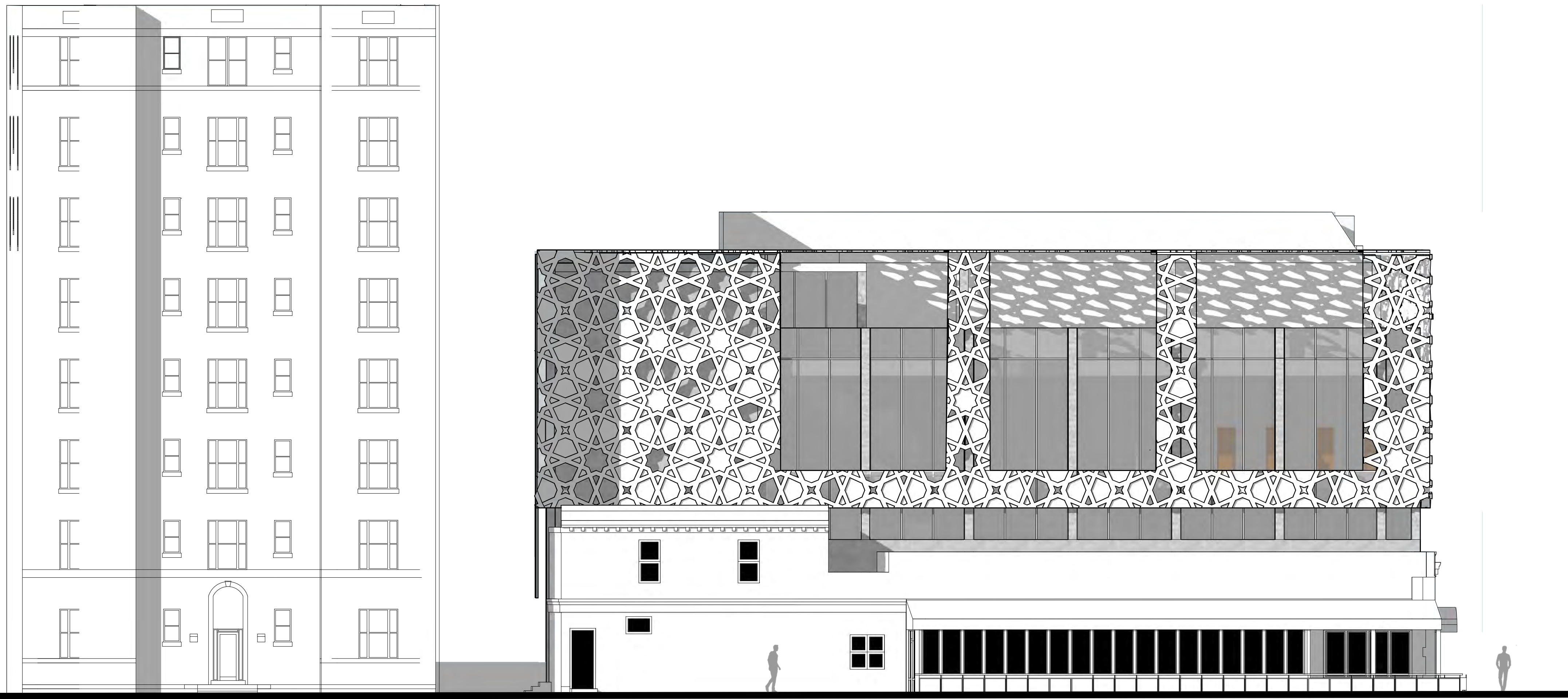

NORTH ELEVATION
1' = 1/8"

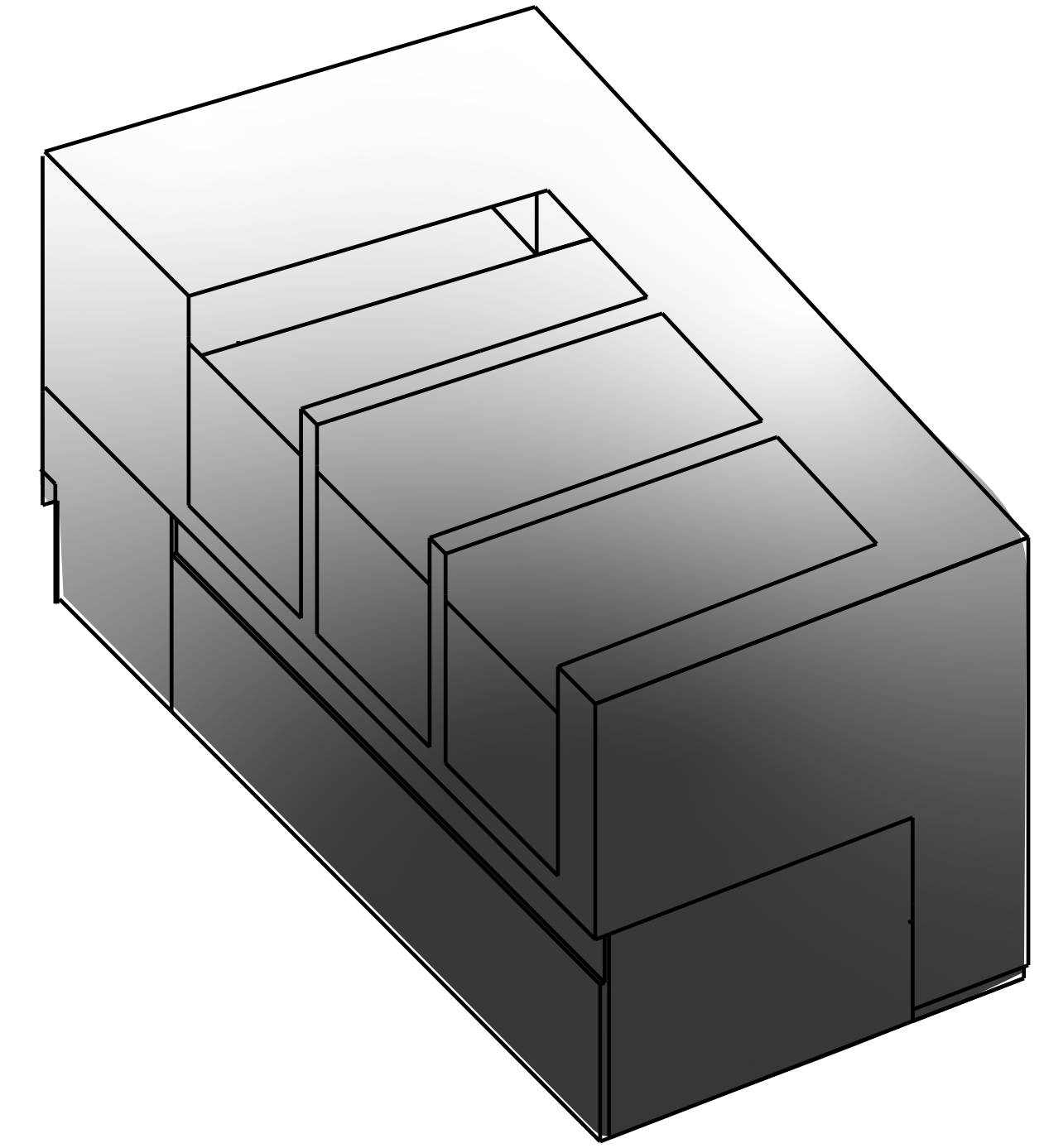

PART I

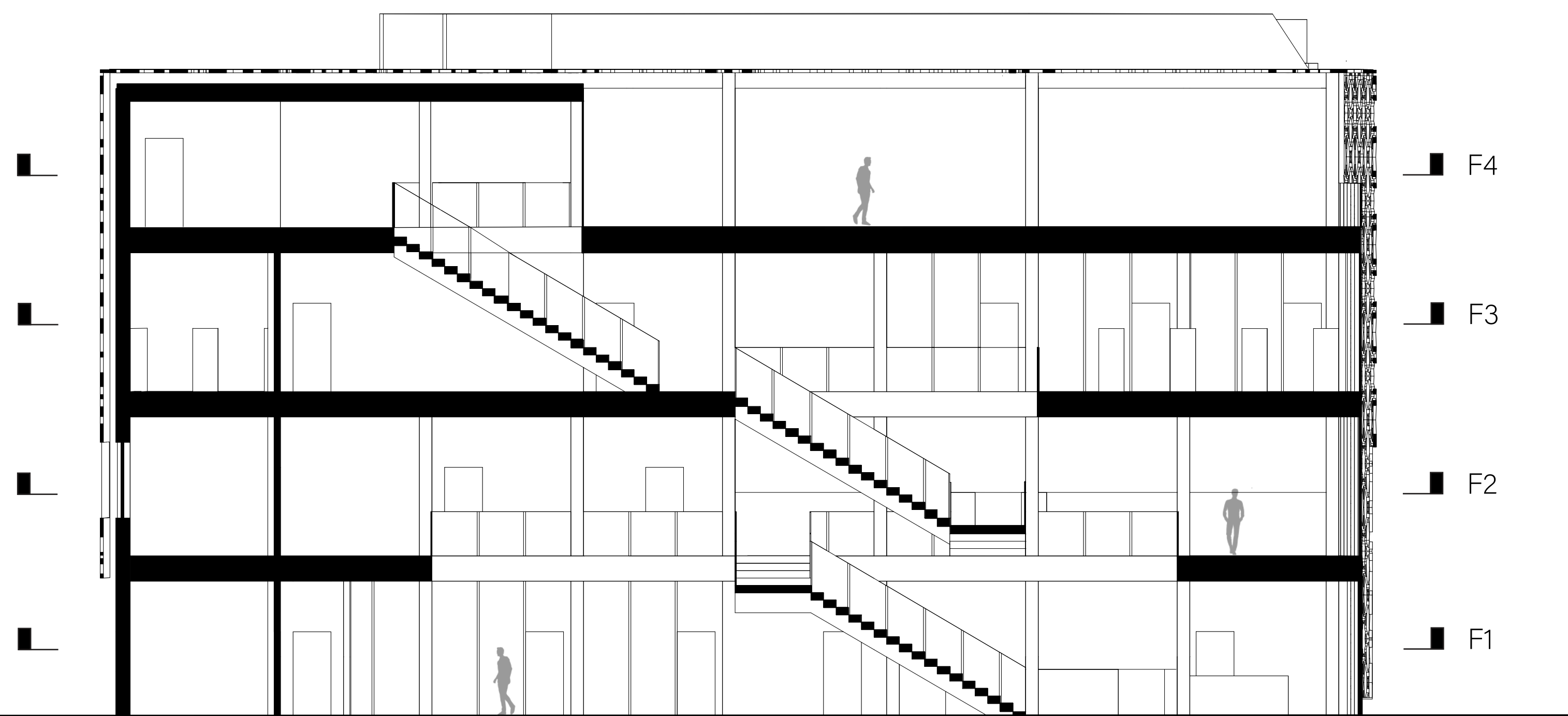
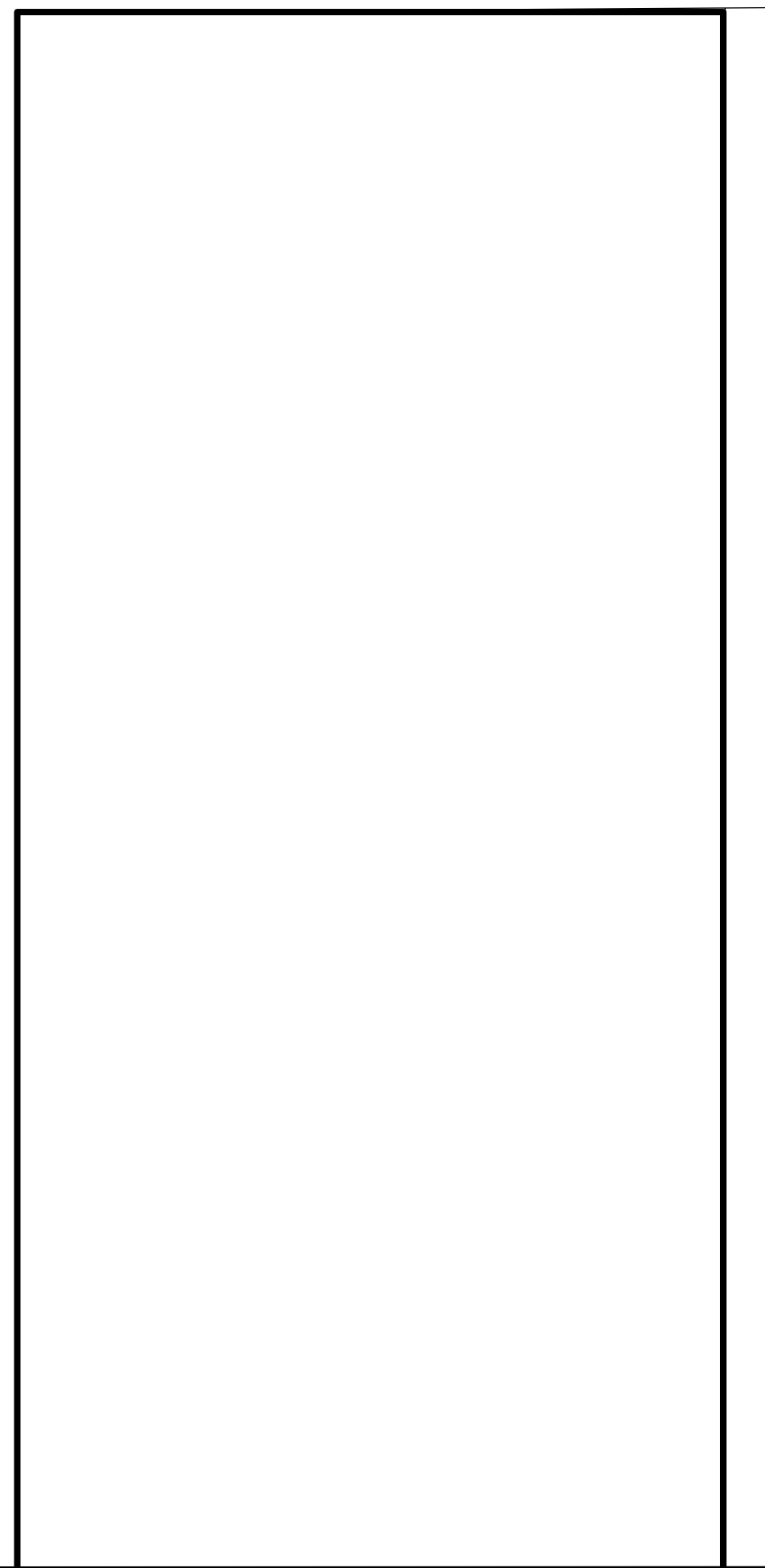

SECTION 2
1' = 1/8"

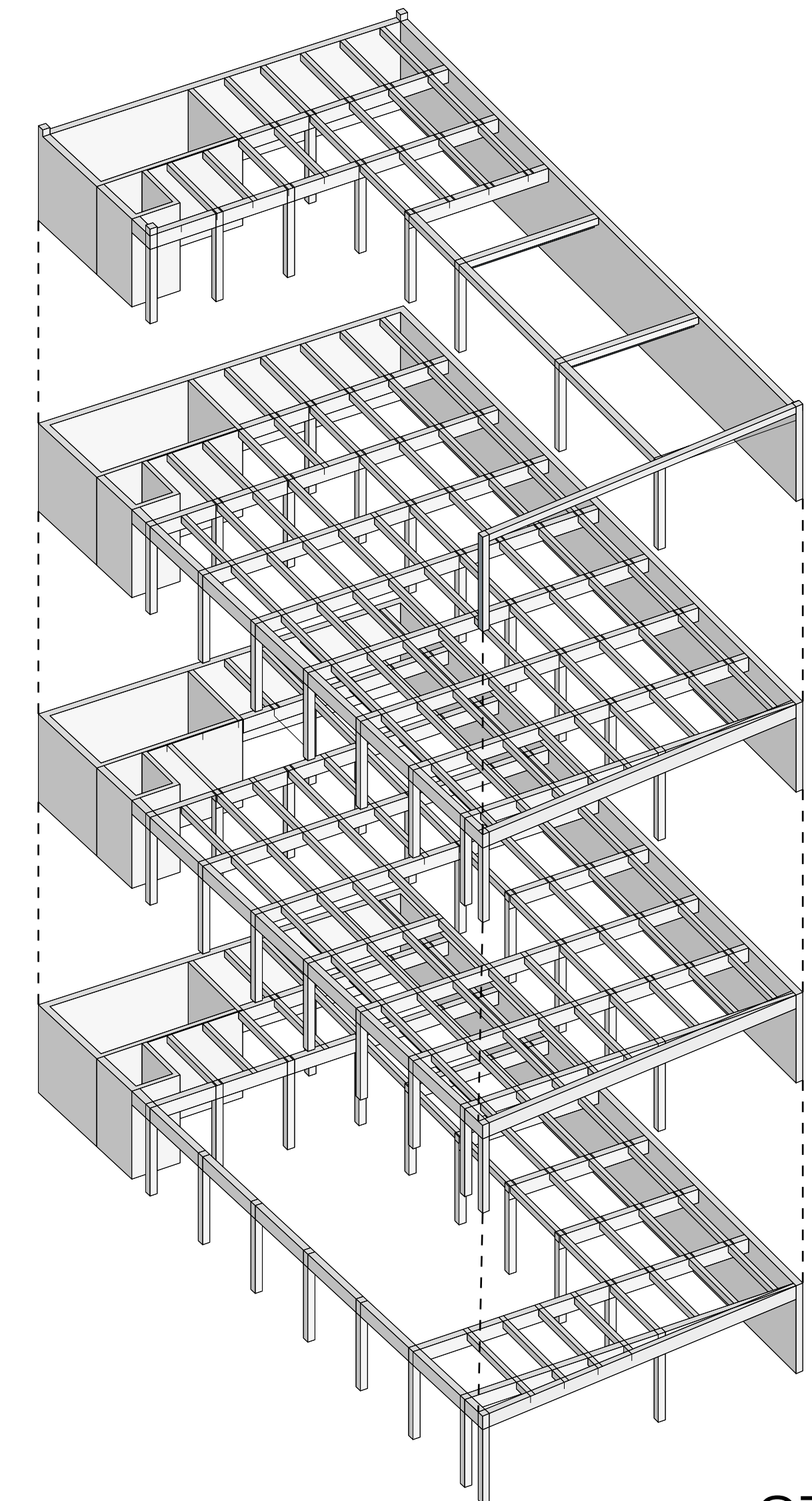

STRUCTURE